



PREGLED PROIZVODA

Rešenja za stezanje
i automatizaciju

destaco.com

GENERALNA BROŠURA

TRŽIŠTA



AVIJACIJA



AUTO INDUSTRIJA



POTROŠAČKA DOBRA



HRANA & PAKOVANJE



INDUSTRIJA



LOGISTIKA



Fokusiranje svih naših resursa

Razvoj novih proizvoda

DESTACO fokusira sve svoje resurse na dizajn i izgradnju sledeće generacije proizvoda i rešenja.

Korisnička i tehnička podrška

DESTACO ima vodeću globalnu podršku u industriji za rešavanje svih problema sa proizvodima i aplikacijama koje imate.

Alati za dizajn

DESTACO pruža opsežnu CAD biblioteku, softver za dimenzioniranje i onlajn alate za podršku našim globalnim klijentima.

Naš uvid radi za vas

Aplikativno projektovanje

Koristimo našu stručnost i kompletan portfolio proizvoda da bismo kreirali rešenja koja odgovaraju potrebama i aplikacijama naših kupaca.

Prilagođena rešenja

Ako se naša gotova rešenja ne uklapaju, udružićemo se sa našim klijentima kako bismo razvili proizvode koji će odgovarati vašim potrebama.

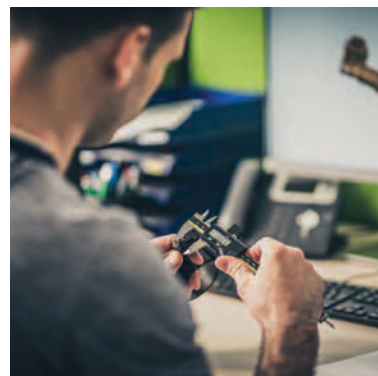
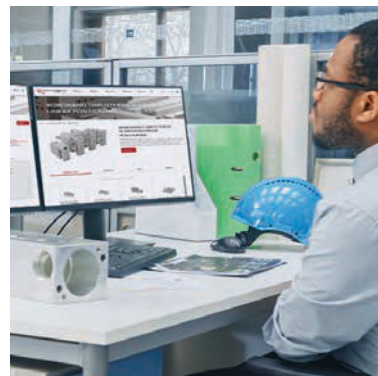

Kada se gotov proizvod ne može uklopiti - mi možemo!

Sa dugogodišnjim iskustvom u radu sa proizvođačima OEM mašina, možemo da učinimo da naš proizvod odgovara vašoj jedinstvenoj primeni. Udružićemo se sa vama da dizajniramo pravi proizvod za vašu primenu – od promene postojećeg proizvoda do izrade potpuno novog proizvoda, imamo iskustvo i stručnost da pomognemo vašem projektu da uspe.

Koristeći našu stručnost za razvoj prilagođenih rešenja za jedinstvene aplikacije, DESTACO vam pomaže da uštedite vreme i resurse, omogućavajući vam da se fokusirate na svoj osnovni posao i steknete konkurentsku prednost na tržištu.

- Proveren kvalitet od strane stručnjaka
- Smanjite rizik korišćenjem naših iskusnih inženjera
- Lako ponovno naručivanje sa jedinstvenim šiframa
- Pojednostavite svoj lanac snabdevanja
- Tri nivoa prilagođavanja od jednostavnih izmena do složenih prilagođenih proizvoda

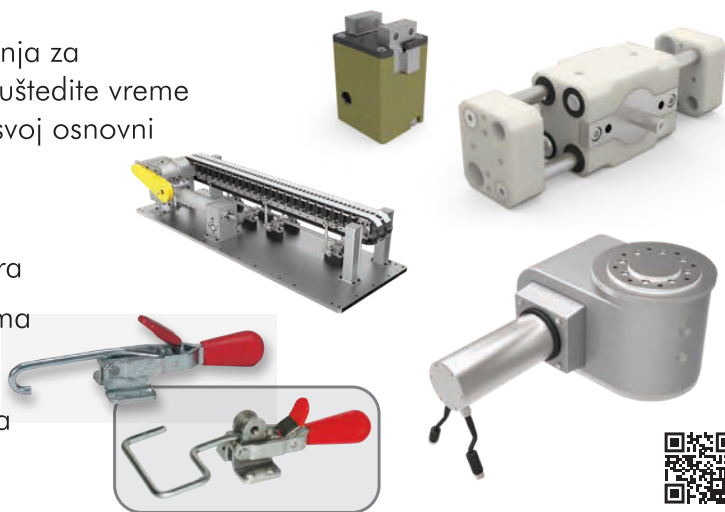

AUTOMATIZACIJA - ROBORUKE, ROTACIONI I KLIZNI HVATAČI

OEM proizvodi



Električni paralelni griperi



Paralelni griperi

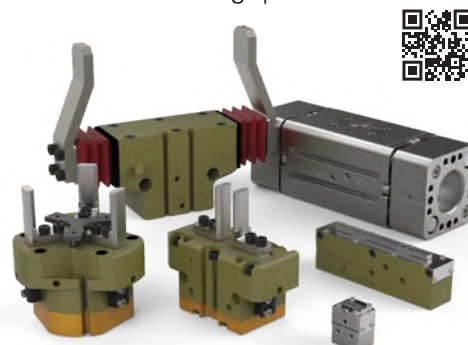

Ugaoni griperi

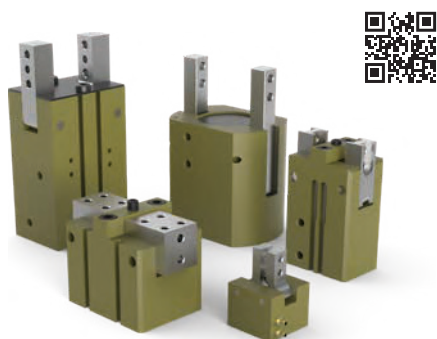

Specijalni griperi



ROBOHAND

Rotacioni
aktuatori



Linearni klizači



Stepenasto napajanje

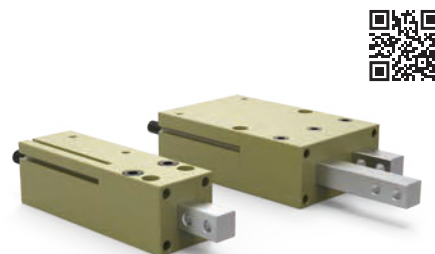

AUTOMATIZACIJA - CAMCO SERVO I MEHANIČKI POZICIONERI

Servo pozicioneri/rotacioni stolovi



Mehanički reduktori

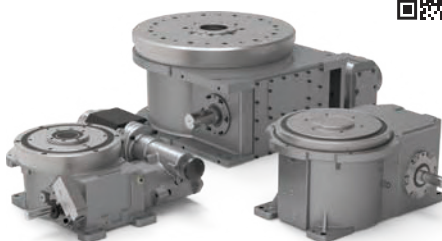

Mehanički reduktori sa indeksom

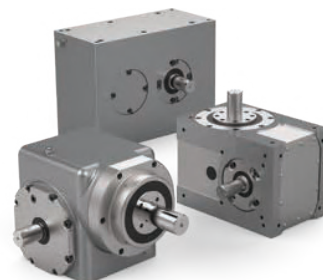

Kružni reduktori/indeksi



Manipulatori

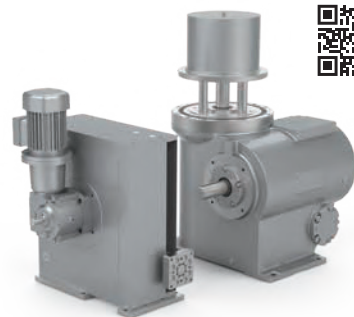

CAMCO

Prenosni sistemi

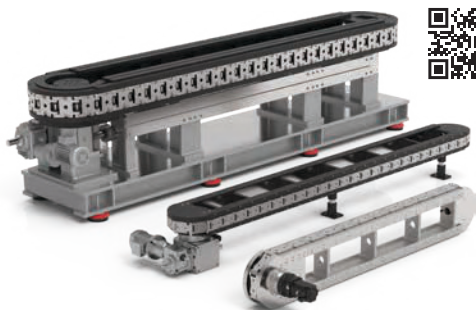

Spojke preopterećenja



Bregasti sistemi



RUČNE I PNEUMATSKE STEGE

Vertikalne stege



Horizontalne stege

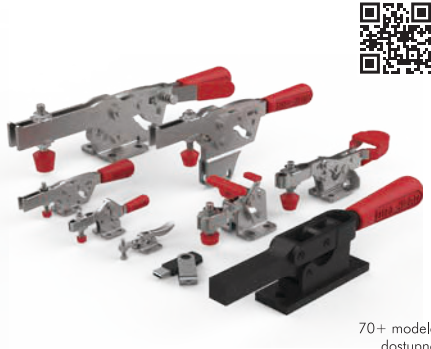

Potisne stege



Klešta stege

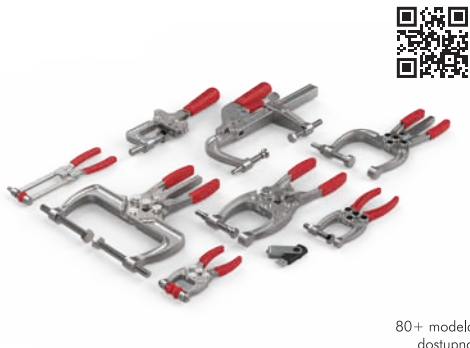

Potezne stege



Pneumatske pritisne stege



Pneumatske rotirajuće stege



Pneumatski pogonski cilindri



Pneumatske okretnne stege



Električno stezanje i pozicioniranje



Pneumatske stege

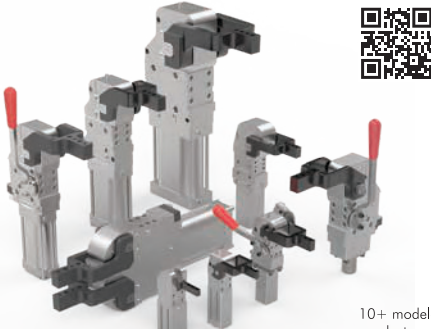

Pneumatsko lociranje i pozicioniranje



SISTEMI ALATA I COBOT REŠENJA

Mali teretni roboti
& Cobot rešenja



Accelerate® lagani alati

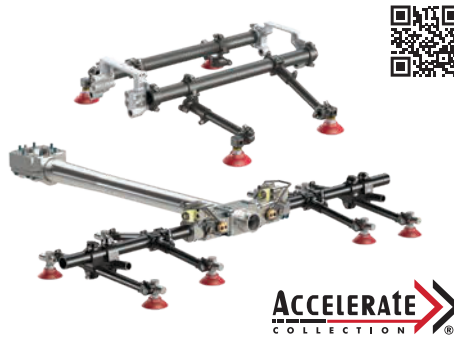

Kompozitna alatna grana



Izmenjivači alata &
uređaji za usaglašavanje



SpiderGrip™ geometrijski
sistemi alata



BodyBuilder™ osmougoni
sistemi alata



TC1 manualni izmenjivač
alata/spojnica



Griperi za lim & Accelerate®
pritsini griperi



Fleksibilni griperi za kese
& paletiranje

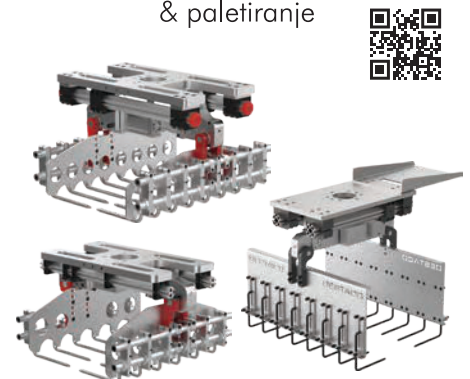

ARV® Automatsko rasterećenje
venturi sistema



Vakuumske šolje i
proizvodi



Destacker proizvodi



KLIKNI ILI SKENIRAJ

Za više informacija o ovim proizvodima,
klikni ili skeniraj odgovarajući QR kod

DIGITALNA LITERATURA I RESURSI

Ručno i pneumatsko stezanje

Vizuelni vodič za izbor



Pneumatsko stezanje, lociranje i pozicioniranje

Vizuelni vodič za izbor



Mali teretni robot/ kobot rešenja

Vizuelni vodič za izbor



Roboruke

Vizuelni vodič za izbor



Griperi za lim

Vizuelni vodič za izbor



Sistemi alata & vakuum proizvodi

Vizuelni vodič za izbor



Izmenjivači alata i usklađivanje

Vizuelni vodič za izbor



Camco indekseri, transporteri i rukovaoci delovima

Pregled proizvoda



CRL rešenja za daljinsko rukovanje i zadržavanje

Vebsajt



Ponuda i dostupnost proizvoda mogu se promeniti bez prethodne najave

GLOBALNI KONTAKTI

KORPORATIVNO SEDIŠTE



US

+1-888-DESTACO
+1-248-836-6700
northamerica@destaco.com

NAJBOLJI PROIZVODI.
NENADMAŠNA USLUGA.
ŠIROM SVETA.



DE

+49-6171-705-0
europe@destaco.com



SP

+34-936361680
spain@destaco.com



PL

+48-506002115
poland@destaco.com



IN

+91-80-41123421-426
india@destaco.com



MX

mexico@destaco.com



FR

+33-4-7354-5001
france@destaco.com



CN

+86-21-6081-2888
china@destaco.com



NL

+31-297285332
benelux@destaco.com



SG

singapore@destaco.com



UK

+44-1902-797980
uk@destaco.com



TH

+66-2-326-0812
asia@destaco.com



CZ

+420-603-577-341
czech@destaco.com



CA

canada@destaco.com



Klikni ili skeniraj za
poslednju PDF verziju
ovog dokumenta



Vaš kontakt:

 **HALDER**
SRBIJA

Halder d.o.o.
Aleja Milanović bb, 34325 Lužnice
Telefon: +381 (0) 34 332 415
info@halder.rs, www.halder.rs

**SKENIRAJ -
KONFIGURATOR ZA IZBOR
PROIZVODA I VELIČINE**

